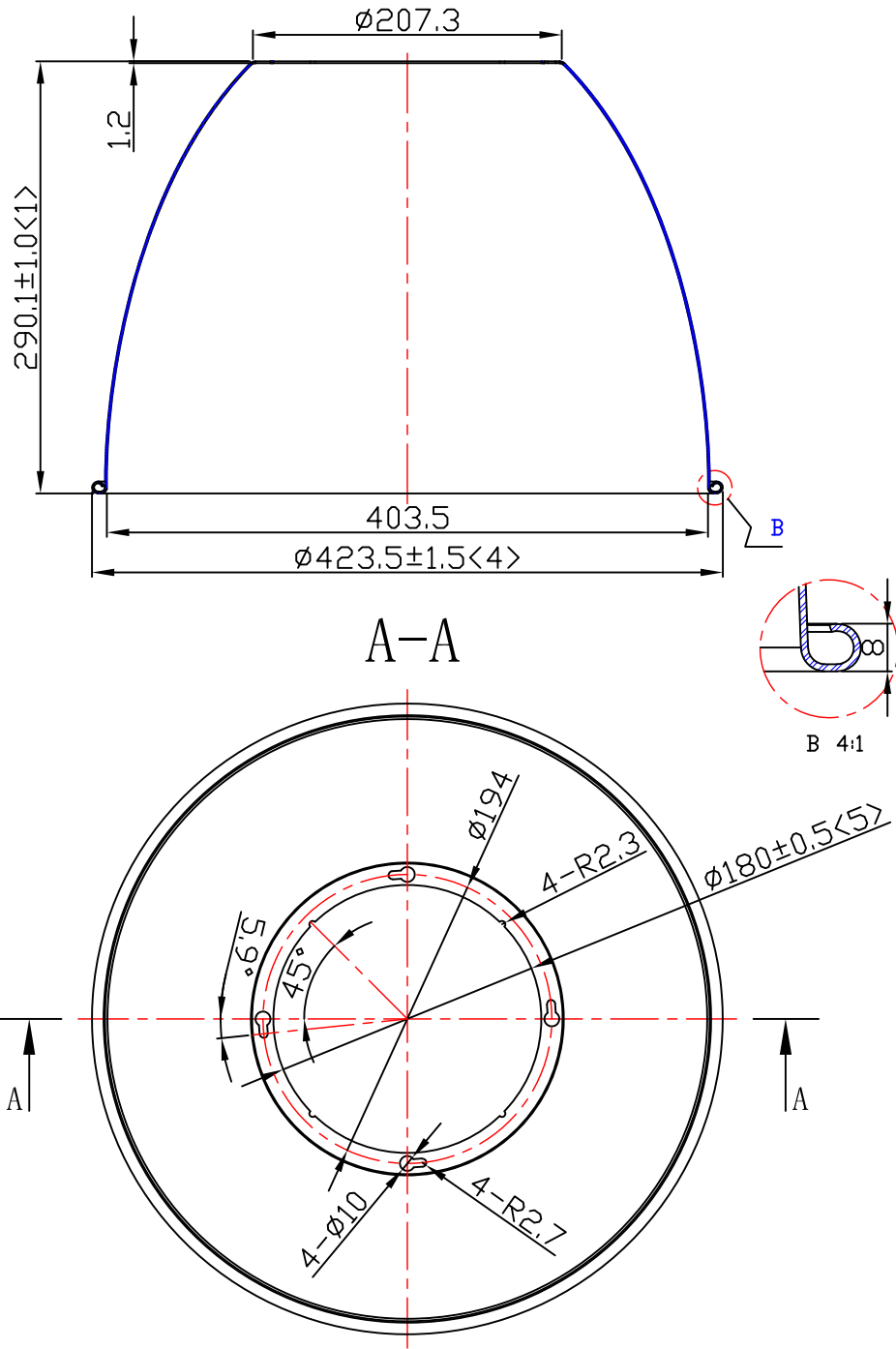

table for unmentioned tolerance in the drawing (unit: mm)			punch angle tolerance in the drawing (unit:degree)		
0-5	5-30	30-120	0-10	10-50	50-120
±0.15	±0.2	±0.5	±1°	±0.5°	±0.3°
120-250	250-400	400-700	120-250	250-360	360 above
±0.8	±1.5	±2	±0.2°	±0.166°	±0.083°



					Material:T=1.2 1070AL		Nata [®]	
Mark	Amended Times	Amended Content		Signature	Amended Date	Customer Item		
Control Version	A0	Design Version	K0	Client Version		Customer Code		NT
Designer		Drawing by		Proportion	1:1	Product Number		
Technology		Auditor		View		Product Name		16-0042-A
Approval		Date	2019.05.05	Page	Total_ Page_			